

# Keysight Technologies

## PXI RF Switch Modules

DC to 3 GHz

M9128A, M9146A, M9147A, M9148A, M9149A,  
M9150A, M9151A, M9152A, M9153A

Challenge the boundaries of test

Keysight modular products

Data Sheet



**PXI**



# Introduction

## Product Description

The Keysight Technologies PXI RF switch modules deliver high-performance, high-density switching up to 3 GHz, and are available in multiple configurations to integrate into a variety of test environments. Modern RF relay technology delivers low insertion loss and VSWR for excellent RF signal integrity and dynamic range when routing RF signals into your measurement equipment. Select from the 8x12 300 MHz full cross point matrix, for connecting multiple points at one time, to the 1x4, 1x8, or 1x16 3 GHz RF multiplexer configurations, for switching multiple points to a single point.

## Applications

- Aerospace and defense
- Electronic test
- Semiconductor test
- Wireless communications

## Features

- Frequency range: DC to 3 GHz
- Multiple configurations including high-density models
- 50 and 75 ohm versions
- High-quality SMB connectors
- Low insertion loss and VSWR for excellent RF signal integrity
- Software drivers to support most common programming environments
- High density RF switching in a PXI form factor
- Chassis connector compatibility: cPCI (J1), PXI-1 (J1 only), PXIe hybrid slot

## Customer values

- High-density RF switching in a single PXI slot
- Excellent RF signal integrity and dynamic range
- Repeatable RF performance
- Work in your environment of choice and reduce development time
- Fast and easy installation and configuration

## Easy setup ... test ... and maintenance

### Hardware platform

#### Compliance

The RF switch modules are PXI compliant with a J1 connector and can be used in PXI chassis with cPCI (J1), PXI-1 (J1 only), or PCIe hybrid slot connectors.

The PXI format offers high performance in a small, rugged package. It is an ideal deployment platform for many automated test systems. In addition, a wide array of complementary PXI products are currently available, such as multimeters, waveform generators, local oscillators, digitizers, and switches.

### Software platform

#### IO libraries suite

The Keysight IO libraries Suite offers a single entry point for connection to the most common instruments including AXIe, PXI, GPIB, USB, Ethernet/LAN, RS-232 and VXI test instruments from Keysight and other vendors. It automatically discovers interfaces, chassis and instruments. The graphical user interface allows you to search for, verify and update IVI instrument and soft front panel drivers. The IO libraries Suite safely installs in side-by-side mode with NI IO software.

#### Drivers

Keysight provides instrument drivers that work with your choice of software, saving time and preserving software and hardware investments. Keysight modular instruments come with IVI-COM, IVI-C, and LabVIEW software drivers that work in the most popular test and measurement development environments including LabVIEW, MATLAB, LabWindows/CVI, Visual Studio C, C++, C#, VEE, and Visual Basic.

With a broad selection of drivers already included, any Keysight PXI RF switch can be swapped out, replaced, or upgraded with the latest version, requiring only minimal software adjustments.

### Easy software integration

In addition, application code examples are included for LabVIEW, LabWindows/CVI, Visual Studio C, C++, C#, Visual Basic, and MATLAB, providing RF switch set-up and basic functionality. These application code examples are easily modified to quickly integrate the switch module into your measurement system.

### Software applications

Keysight soft front panels provide easy-to-use instrument communications. The PXI RF switch graphical user interface guides developers through module setup so users can quickly configure the switch parameters. More sophisticated functions are also available through the wide selection of instrument program interfaces.

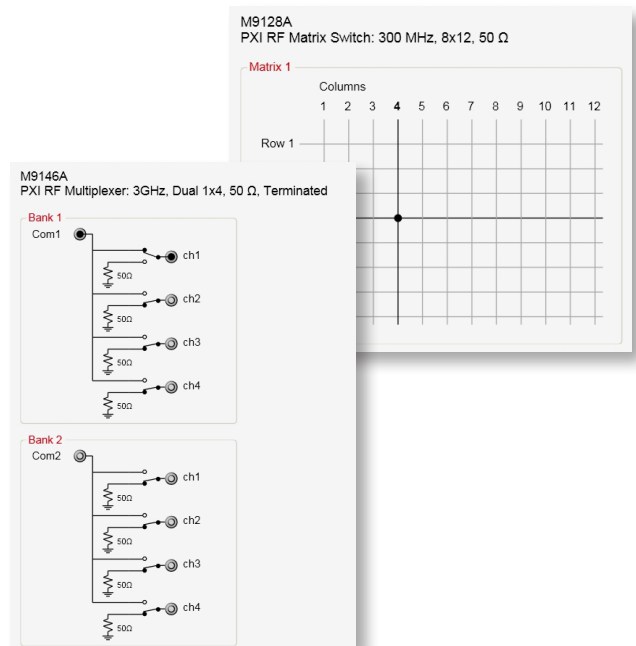

Figure 1. RF switch soft front panel

## Specifications and Characteristics



### Specification and characteristic summary

Following is a summary of specifications and characteristics for the Keysight DC to 3GHz PXI switches. More detailed specifications and characteristics for each module are featured later in this document.

RF switch specification and characteristic summary								
RF switches	Description	Type # slots	Frequency range	Insertion loss ( <i>typical</i> )	Isolation ( <i>typical</i> )	VSWR ( <i>typical</i> )	Impedance ( <i>nominal</i> )	Connectors
M9128A	8 x 12 RF matrix switch	PXI x1	300 Mhz	2 dB @ 300 MHz	40 dB @ 300 MHz	2:1 @ 300 MHz	50 $\Omega$	SMB male connectors
M9146A	Dual 1 x 4 RF multiplexer	PXI x1	3 GHz	0.8 dB @ 3 GHz	45 dB @ 3 GHz	< 1.3:1 to 3 GHz	50 $\Omega$ , off chan termination	SMB male connectors
M9147A	Quad 1 x 4 RF multiplexer	PXI x1	3 GHz	1 dB @ 3 GHz	40 dB @ 3 GHz	< 1.4:1 to 3 GHz	50 $\Omega$ terminated common	SMB male connectors
M9148A	1 x 8 RF multiplexer	PXI x1	3 GHz	0.8 dB @ 3 GHz	40 dB @ 3 GHz	< 1.25:1 to 3 GHz	50 $\Omega$	SMB male connectors
M9149A	1 x 16 high-den- sity RF multiplexer	PXI x1	3 GHz	1.2 dB @ 3 GHz	40 dB @ 3 GHz	< 1.5:1 to 3 GHz	50 $\Omega$	SMB male connectors
M9150A	Dual 1 x 4 RF multiplexer	PXI x1	3 GHz	1 dB @ 3 GHz	45 dB @ 3 GHz	< 1.55:1 to 3 GHz	75 $\Omega$	SMB male connectors
M9151A	Quad 1 x 4 RF multiplexer	PXI x1	3 GHz	1.1 dB @ 3 GHz	40 dB @ 3 GHz	< 1.6:1 to 3 GHz	75 $\Omega$	SMB male connectors
M9152A	1 x 8 RF multiplexer	PXI x1	3 GHz	1 dB @ 3 GHz	45 dB @ 3 GHz	< 1.5:1 to 3 GHz	75 $\Omega$	SMB male connectors
M9153A	1 x 16 RF multiplexer	PXI x1	3 GHz	1.2 dB @ 3 GHz	40 dB @ 3 GHz	< 1.55:1 to 3 GHz	75 $\Omega$	SMB male connectors

## Specifications and Characteristics

### M9128A 8x12 RF matrix

The M9128A contains an 8x12 RF switch matrix in a single PXI module. This switch matrix is used for routing multiple signals up to 300 MHz in a single instance, allowing any combination of channel closures to connect to multiple instruments. Disconnect switches isolate the rows for better overall RF performance.

### Specifications and characteristics

General specifications	M9128A
Channels	8 x 12
Switch type	Matrix
Input impedance	50 $\Omega$
Frequency range	300 MHz
Max volts	30 V
Max current	0.5 A
Switching characteristics, nominal	
Max RF power	10 W
Open/close time	1 ms
Relay life ( <i>typical</i> )	> 20 million @ < 100 mWatts

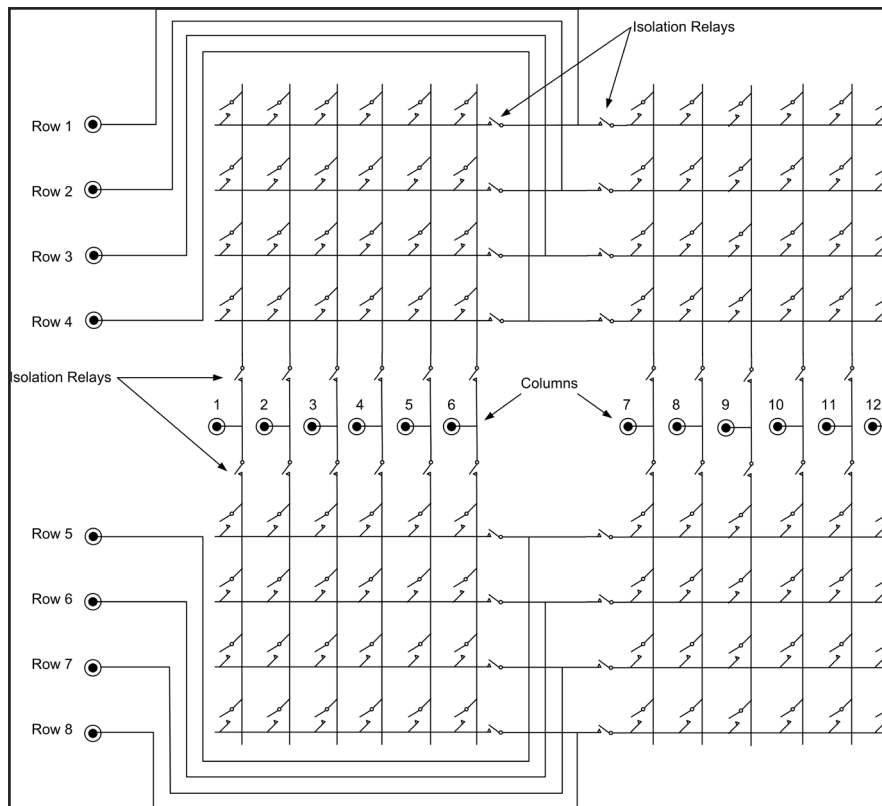
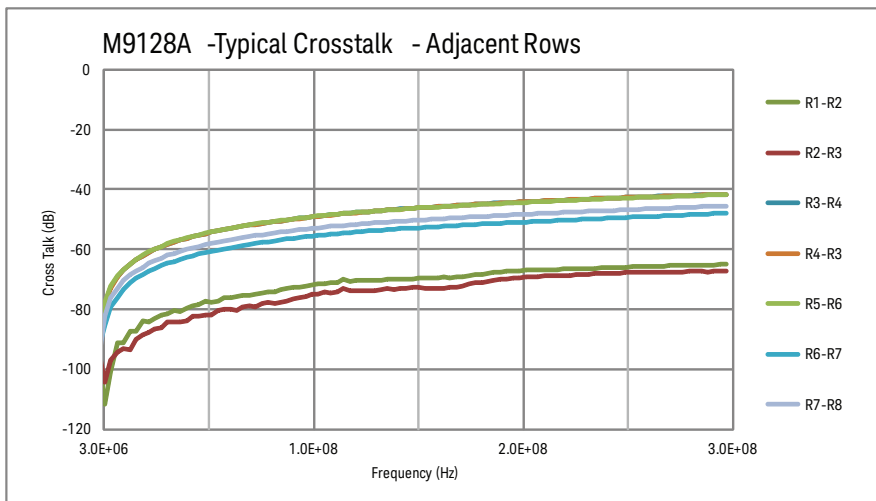
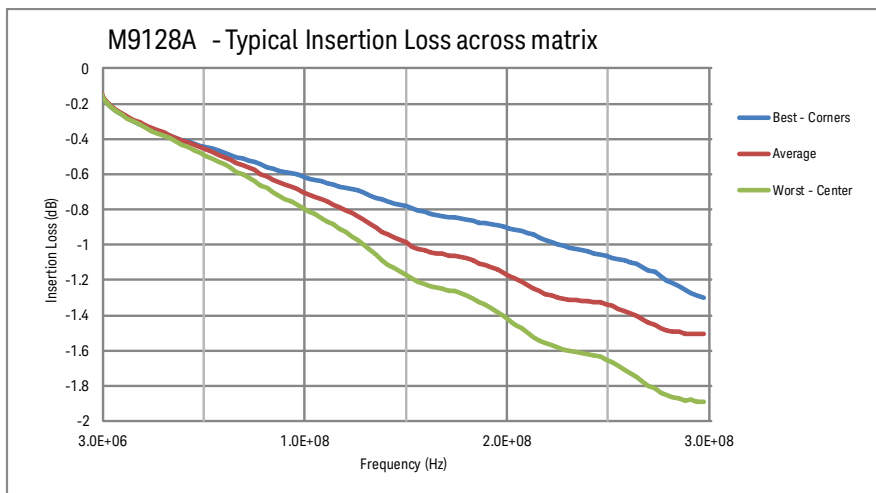
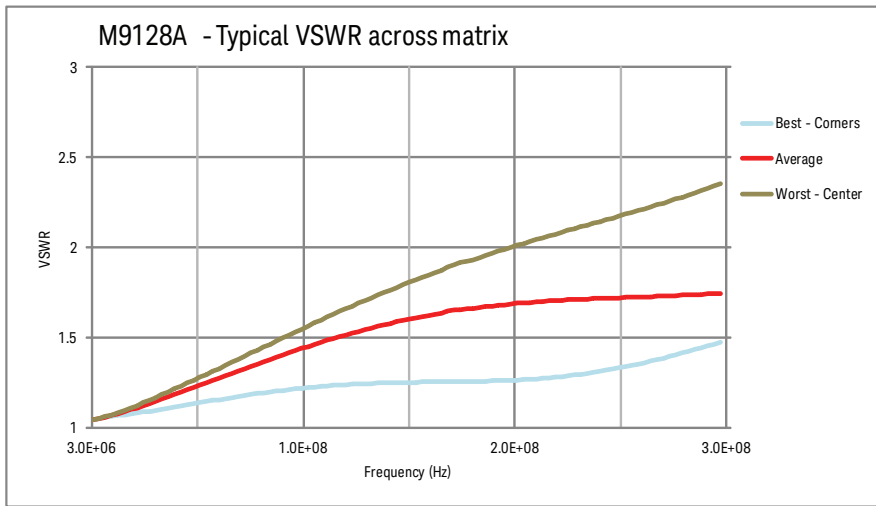

Figure 2. M9128A 8x12 RF matrix

# SPECIFICATIONS and Characteristics

## M9128A typical characteristics



## Specifications and Characteristics

### M9146A and M9150A dual 1x4 RF switch multiplexers

The M9146A and M9150A each contain two 1x4 RF switch multiplexers in a single PXI module. They offer bi-directional switching up to 3 GHz. The M9146A has extra switches to route unused channels into a 50 ohm termination for improved signal integrity—there is also a 75 ohm version, ideal for routing video RF signals. Both modules offer excellent insertion loss and VSWR for better RF signal integrity.

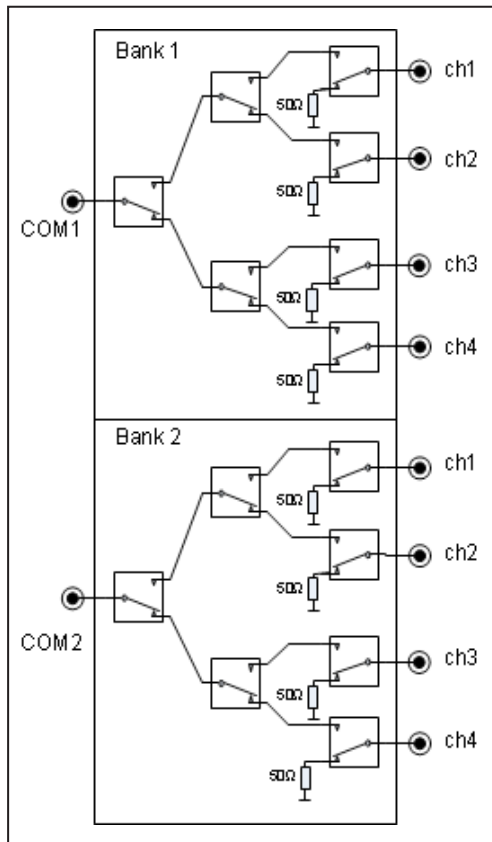

Figure 3. M9146A dual 1x4 RF switch multiplexer

### Specifications and characteristics

General specifications		
	M9146A	M9150A
Channels	Dual 1 x 4	Dual 1 x 4
Switch type	Multiplexer	Multiplexer
Input impedance	50 $\Omega$	75 $\Omega$
Frequency range	3 GHz	3 GHz
Max volts	30 V	30 V
Max current	1 A	1 A
Switching characteristics, nominal		
Max RF power	1 W	10 W
Open/close time	3 msec	3 msec
Relay life ( <i>typical</i> )	10 Million @ < 100 mWatts	

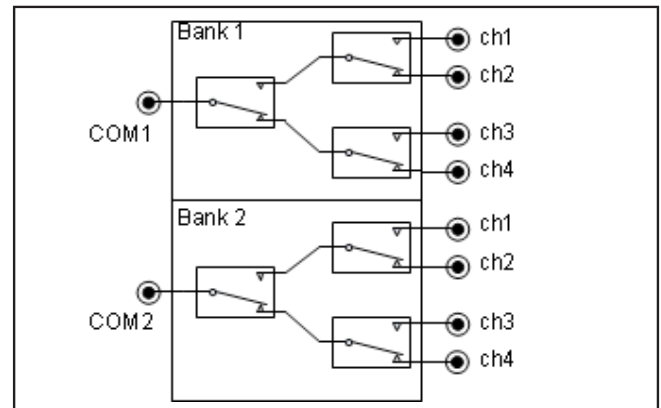
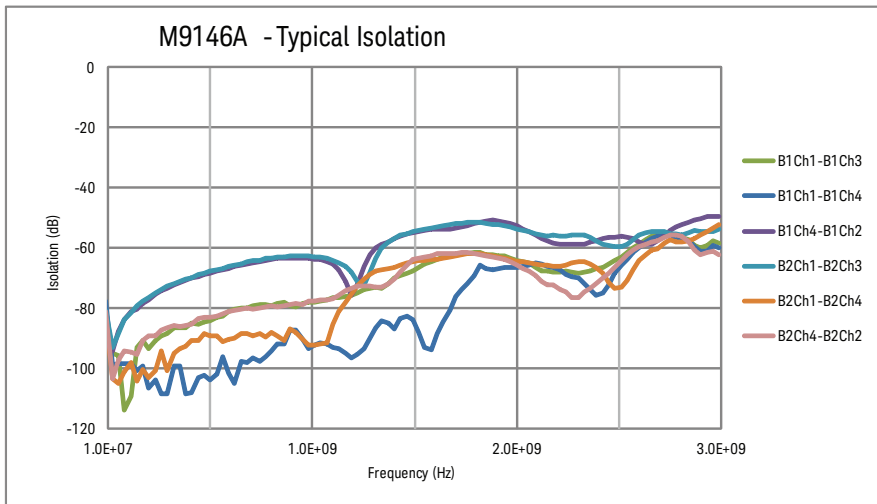
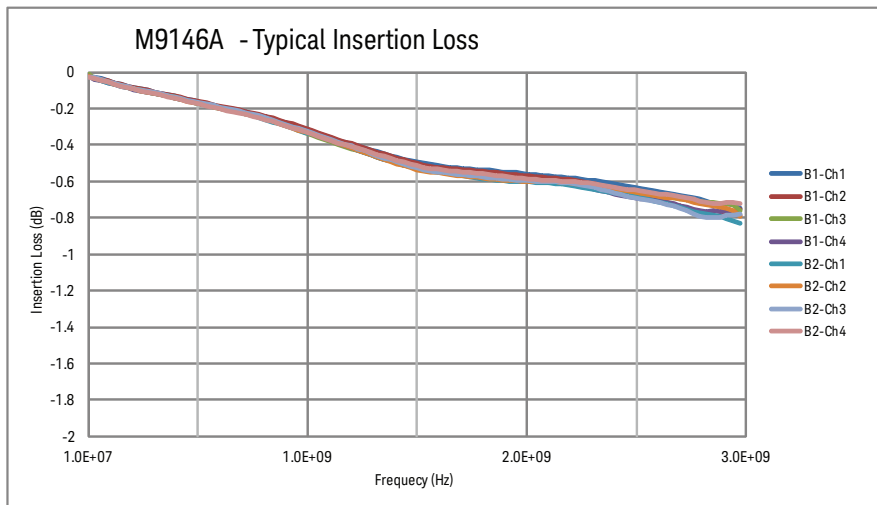
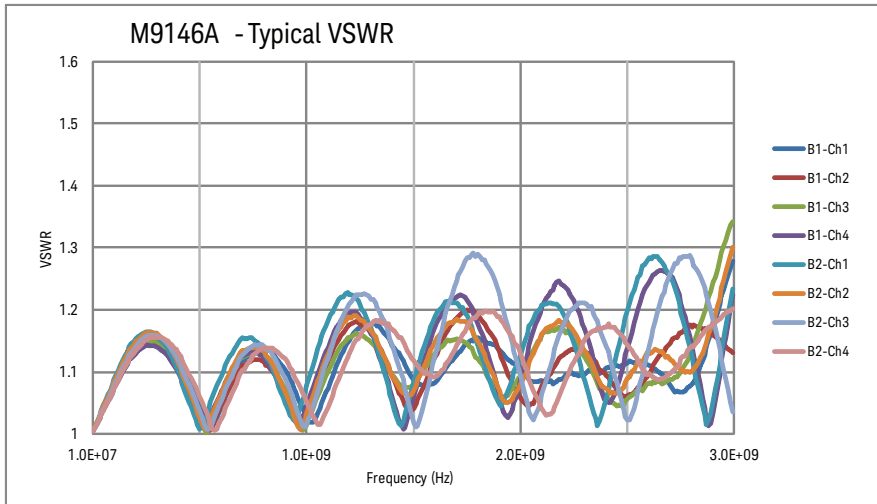

Figure 4. M9150A dual 1x4 RF switch multiplexer

# Specifications and Characteristics

## M9146A typical characteristics





# Specifications and Characteristics

## M9146A typical characteristics (continued)

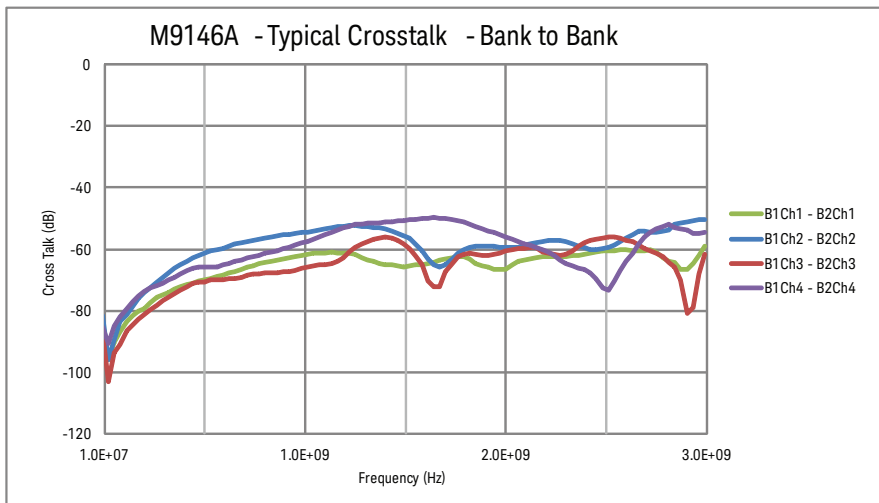
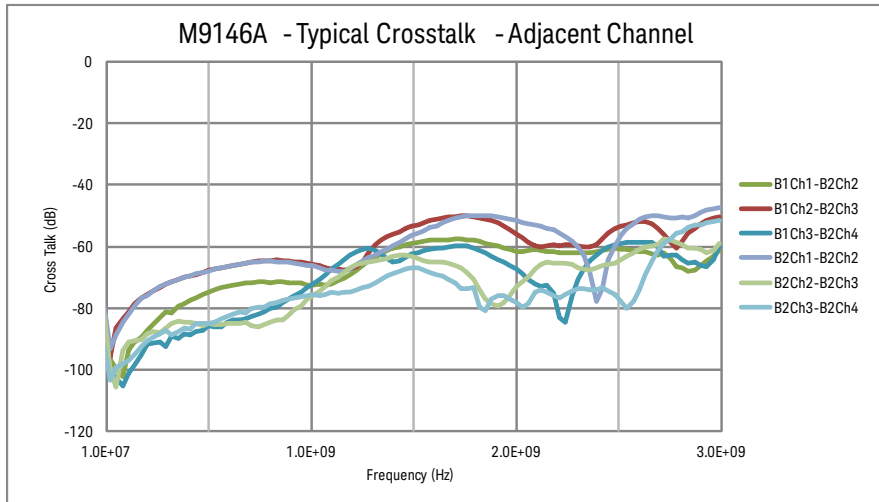

# Specifications and Characteristics

## M9150A typical characteristics

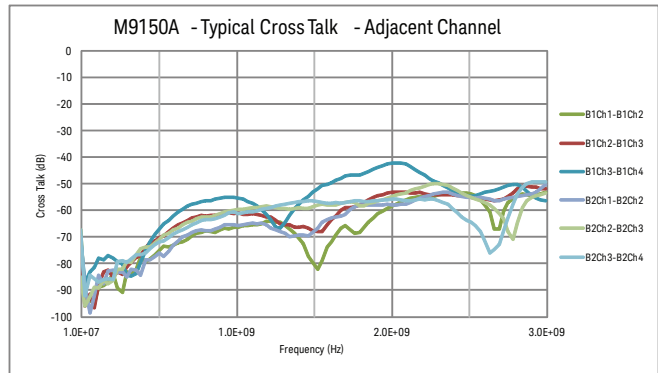
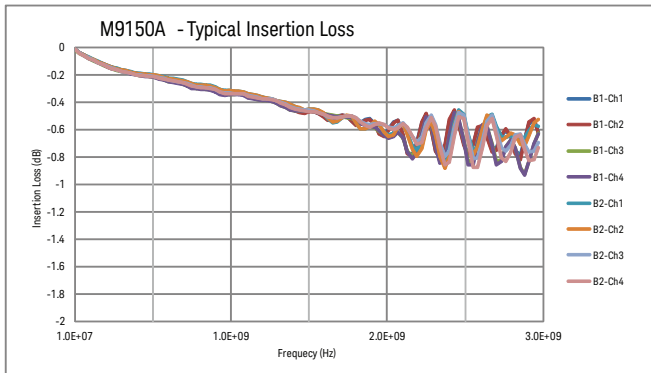
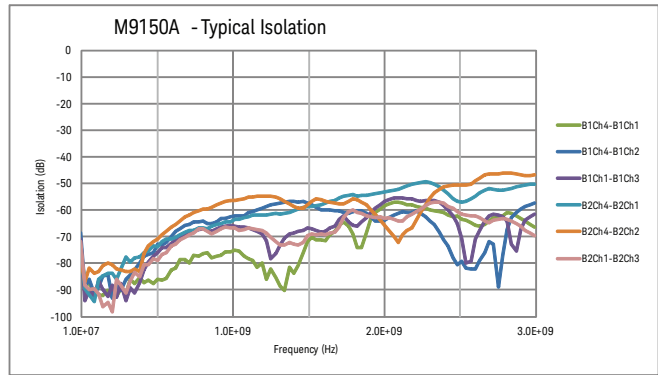
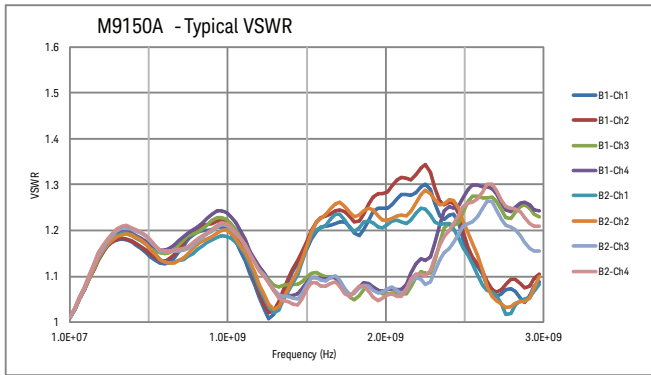

# Specifications and Characteristics

## M9147A and M9151A quad 1x4 RF switch multiplexers

The M9147A and M9151A each contain four 1x4 RF switch multiplexers in a single PXI module. They offer bi-directional switching up to 3 GHz. The M9147A features a terminated common that delivers better insertion loss and VSWR to ensure RF signal integrity.

## Specifications and characteristics

General specifications		
	M9147A	M9151A
Channels	Quad 1x4	Quad 1x4
Switch type	Multiplexer	Multiplexer
Input impedance	50 $\Omega$	75 $\Omega$
Frequency range	3 GHz	3 GHz
Max volts	30 V	30 V
Max current	1 A	1 A
Switching characteristics, nominal		
Max RF power	2 W	10 W
Open/close time	3 msec	3 msec
Relay life ( <i>typical</i> )	10 million @ < 100 mWatts	

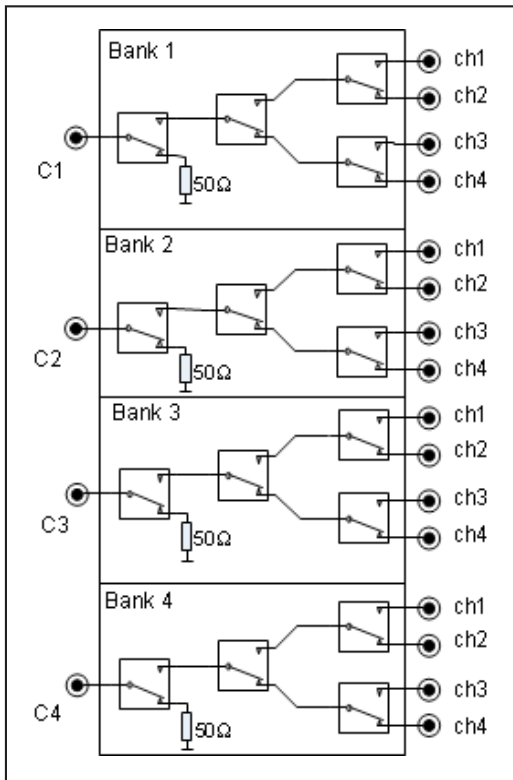

Figure 5. M9147A quad 1x4 RF switch multiplexer

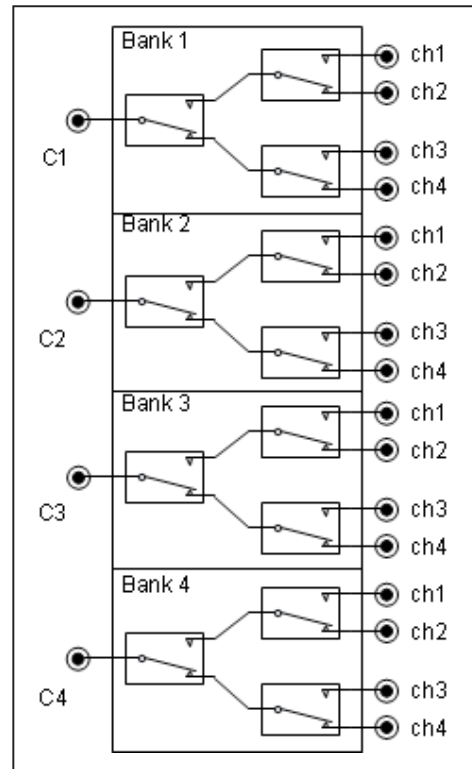
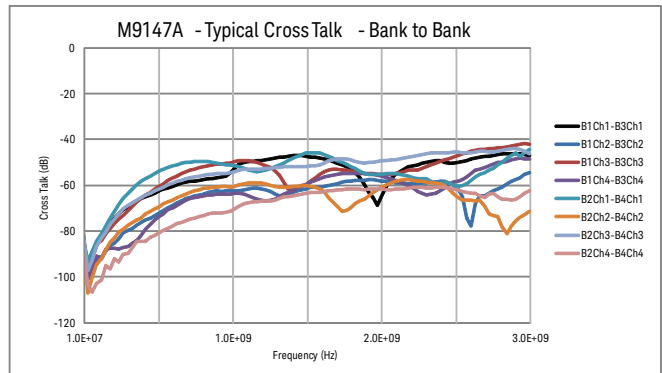
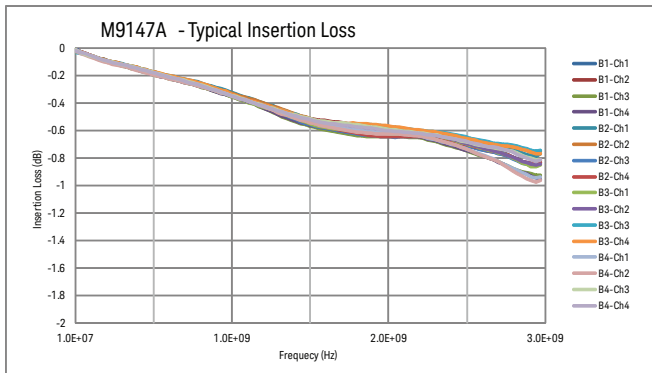
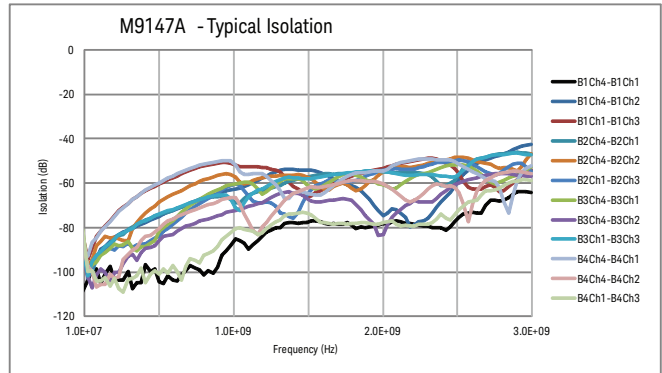
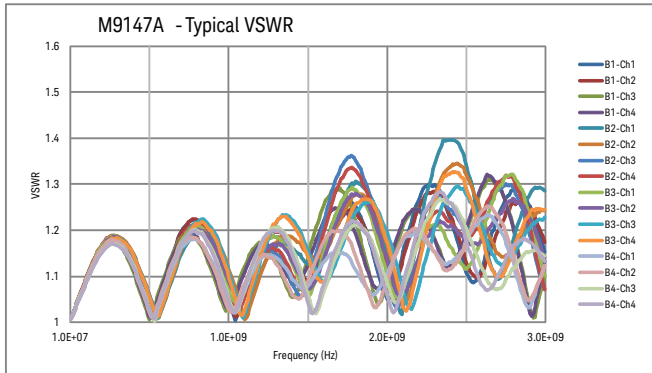

Figure 6. M9151A quad 1x4 RF switch multiplexer

# Specifications and Characteristics

## M9147A typical characteristics



# Specifications and Characteristics

## M9151A typical characteristics

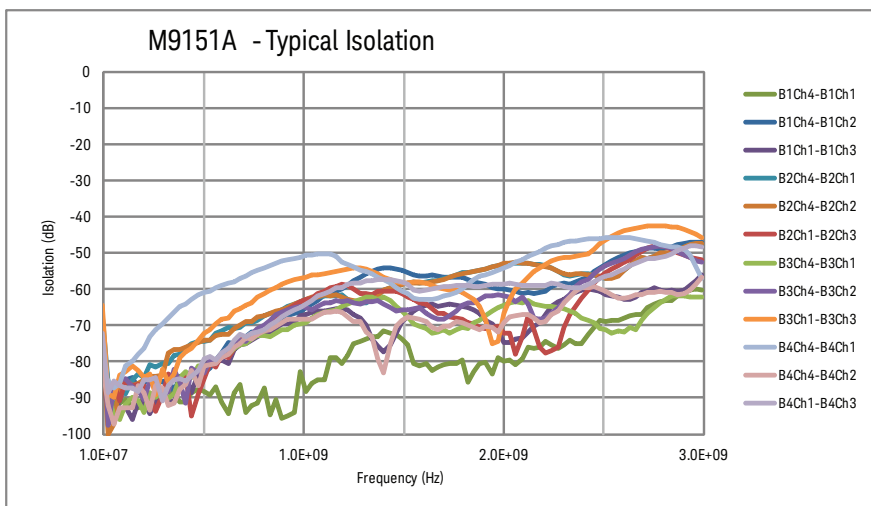
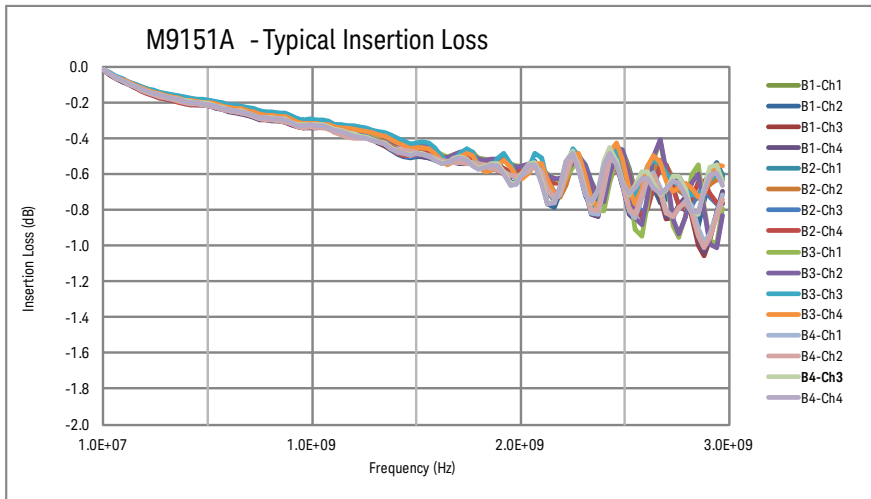
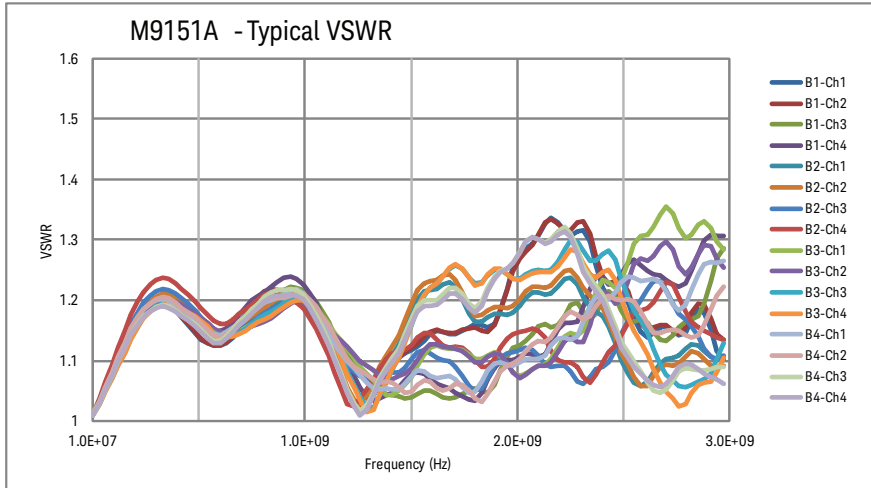

# Specifications and Characteristics

## M9151A typical characteristics (continued)

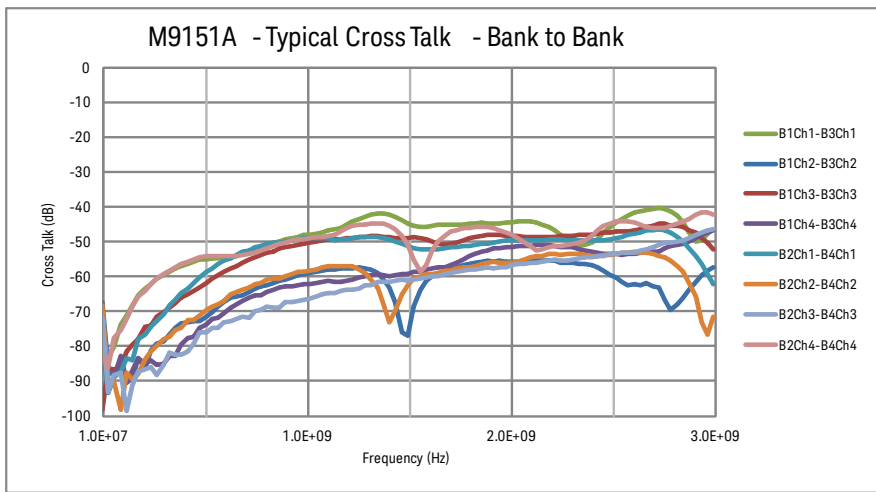
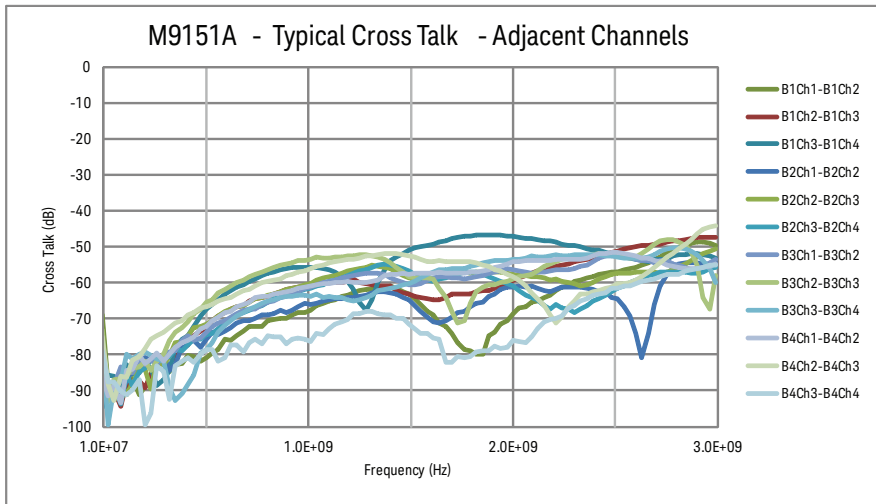

## Specifications and Characteristics

### M9148A and M9152A 1x8 RF switch multiplexers

The M9148A and M9152A each contain a 1x8 switch multiplexer in a single PXI module. They offer bi-directional switching up to 3 GHz. The 1x8 configuration offers excellent insertion loss and VSWR for better RF signal integrity.

### Specifications and characteristics

General specifications		
	M9148A	M9152A
Channels	1x8	1x8
Switch type	Multiplexer	Multiplexer
Input impedance	50 $\Omega$	75 $\Omega$
Frequency range	3 GHz	3 GHz
Max volts	30 V	30 V
Max current	1 A	1 A
Switching characteristics, nominal		
Max RF power	10 W	10 W @ 2 GHz
Open/close time	3 msec	3 msec
Relay life ( <i>typical</i> )	10 million @ < 100 mWatts	

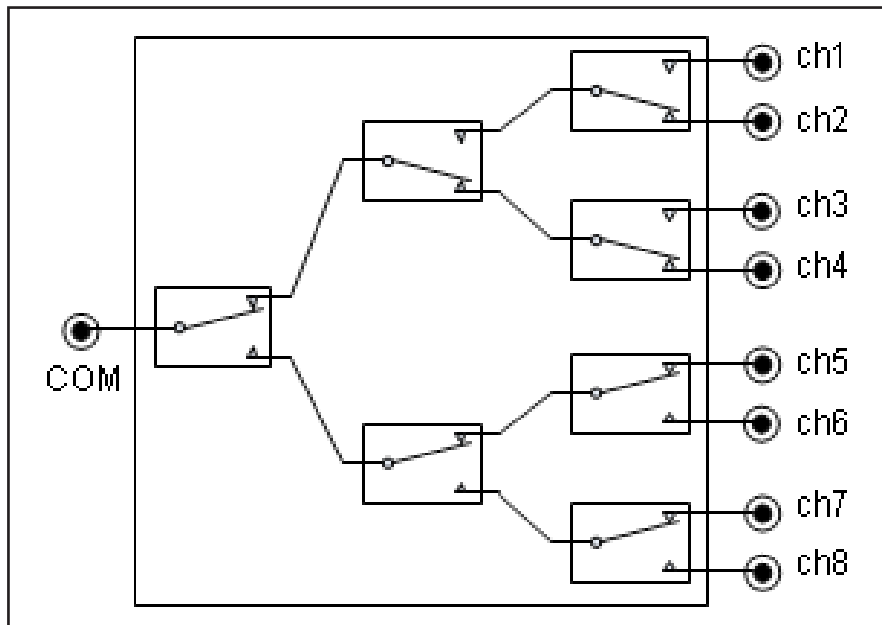
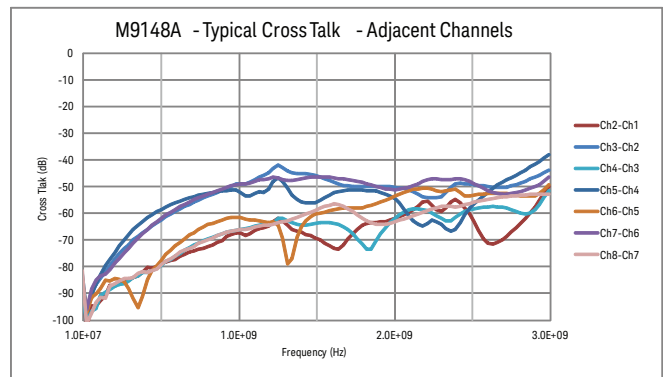
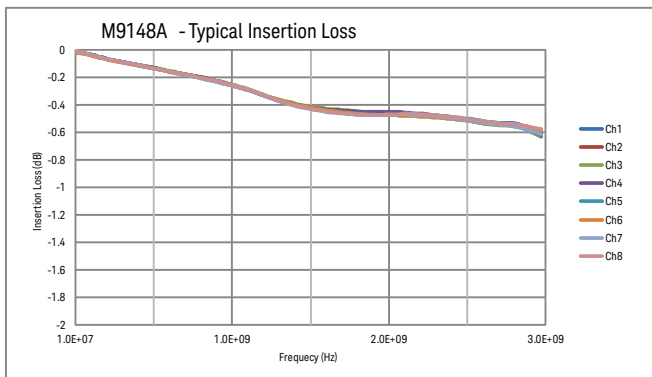
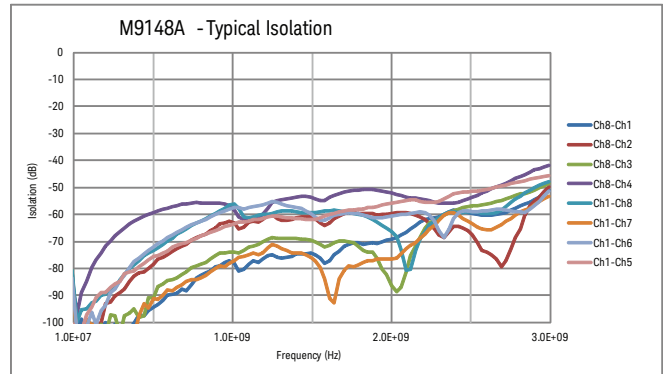
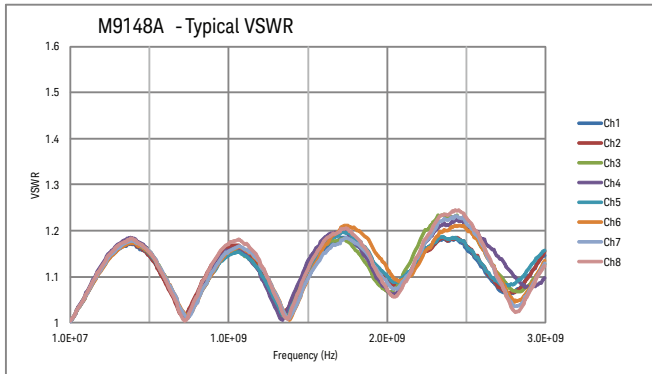

Figure 7. M9148A and M9152A 1x8 RF switch multiplexers

# Specifications and Characteristics

## M9148A typical characteristics





# Specifications and Characteristics

## M9152A typical characteristics

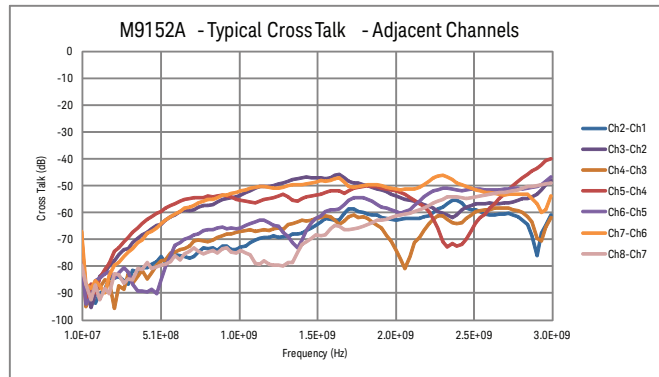
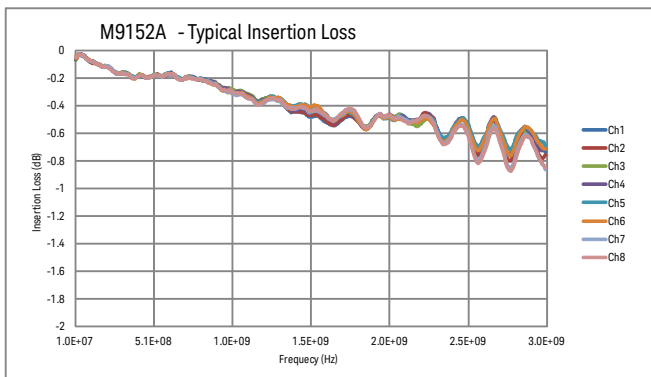
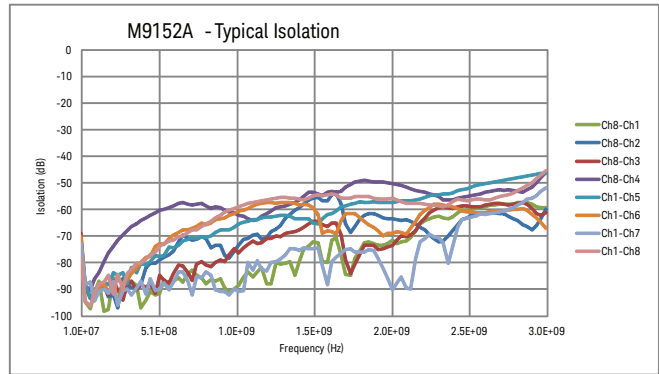
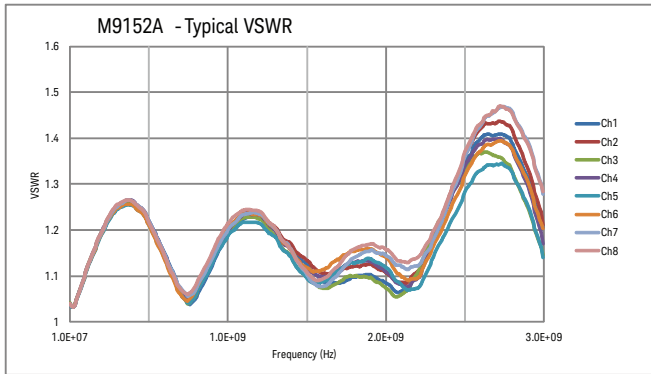

## Specifications and Characteristics

### M9149A and M9153A 1x16 high-density RF multiplexers

The M9149A and M9153A each contain a 1x16 RF switch multiplexer in a single PXI module. They offer bi-directional switching up to 3 GHz. With the 1x16 tree structure, each RF path has been designed for repeatable measurements with excellent insertion loss and VSWR.

### Specifications and characteristics

General specifications		
	M9149A	M9153A
Channels	1x16	1x16
Switch type	Multiplexer	Multiplexer
Input impedance	50 $\Omega$	75 $\Omega$
Frequency range	3 GHz	3 GHz
Max volts	30 V	30 V
Max current	1 A	1 A
Switching characteristics, nominal		
Max RF power	10 W	10 W @ 2 GHz
Open/close time	3 msec	3 msec
Relay life ( <i>typical</i> )	10 million @ < 100 mWatts	

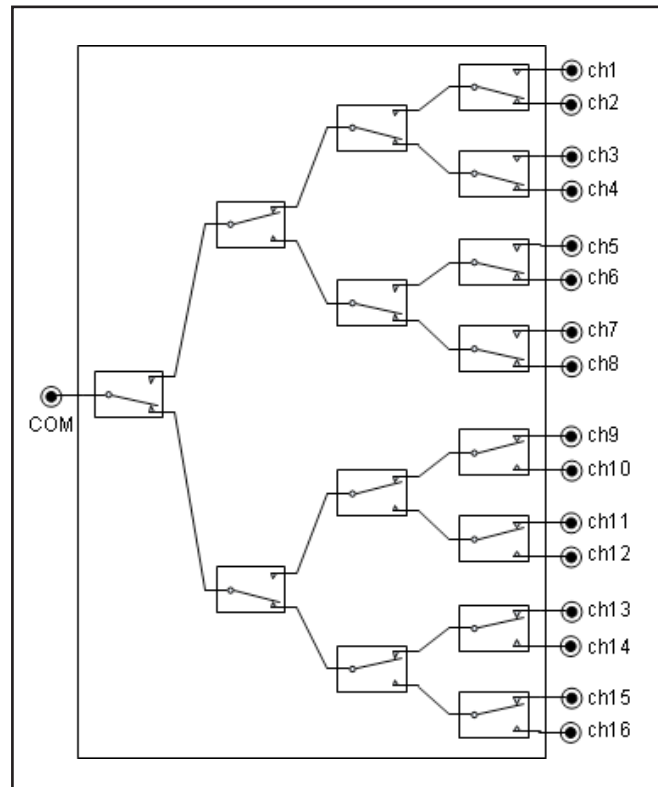
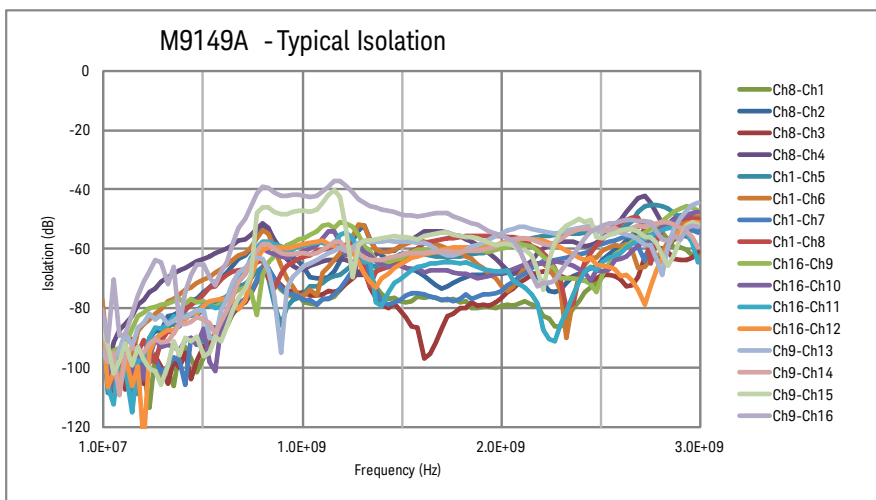
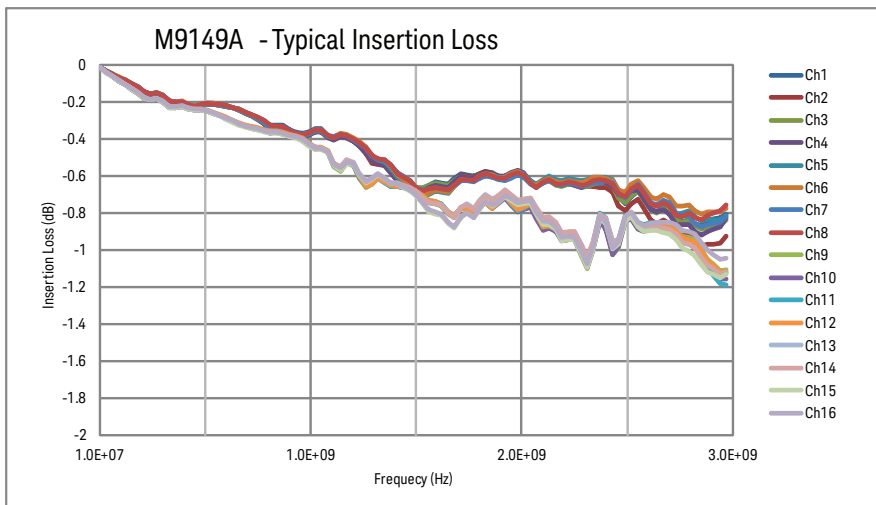
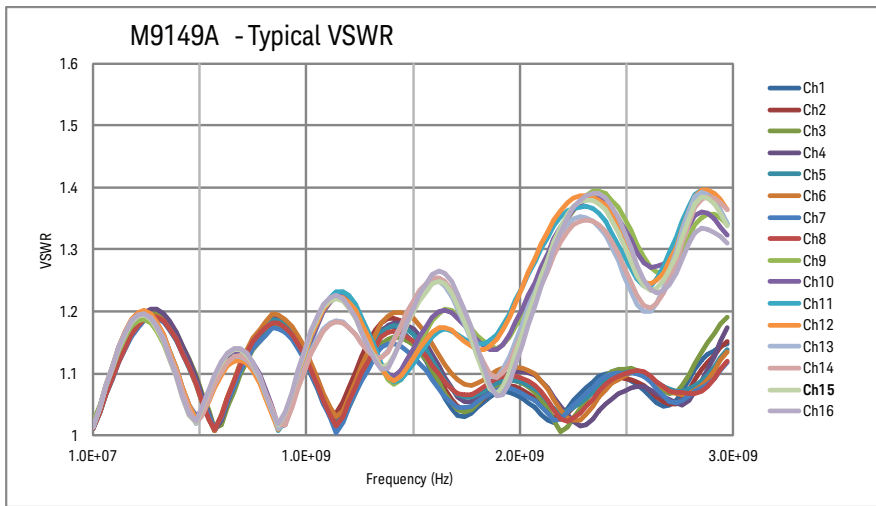

Figure 8. M9149A and M9153A 1x16 high-density RF multiplexers

# Specifications and Characteristics

## M9149A typical characteristics



# Specifications and Characteristics

## M9149A typical characteristics (continued)

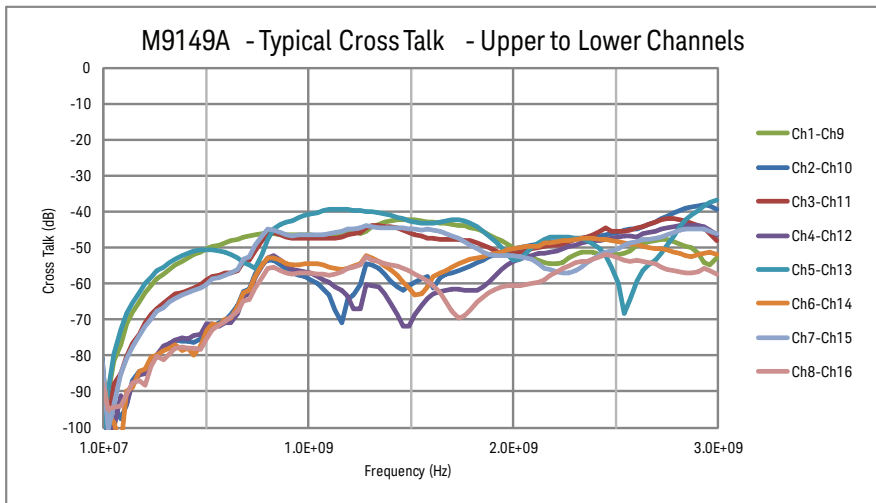
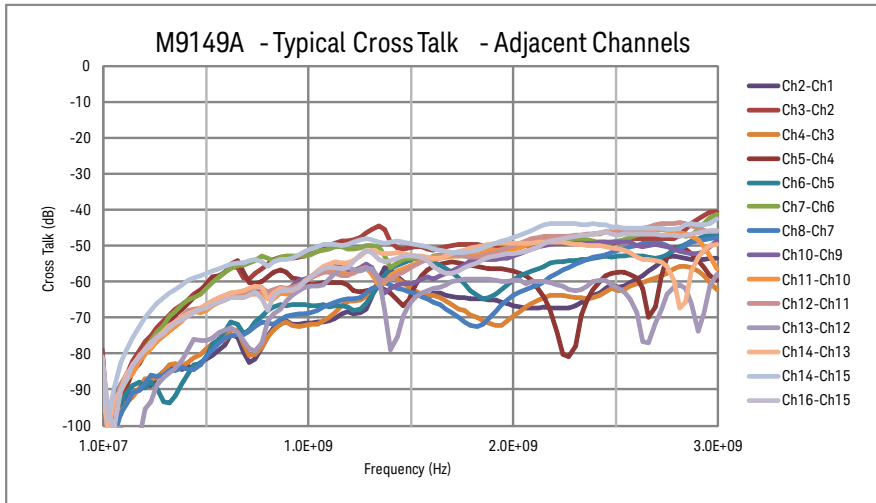

# Specifications and Characteristics

## M9153A typical characteristics

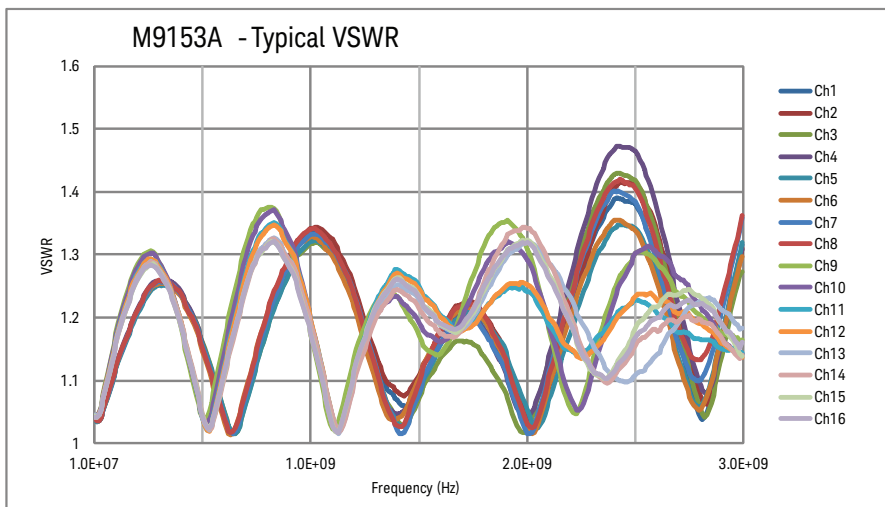
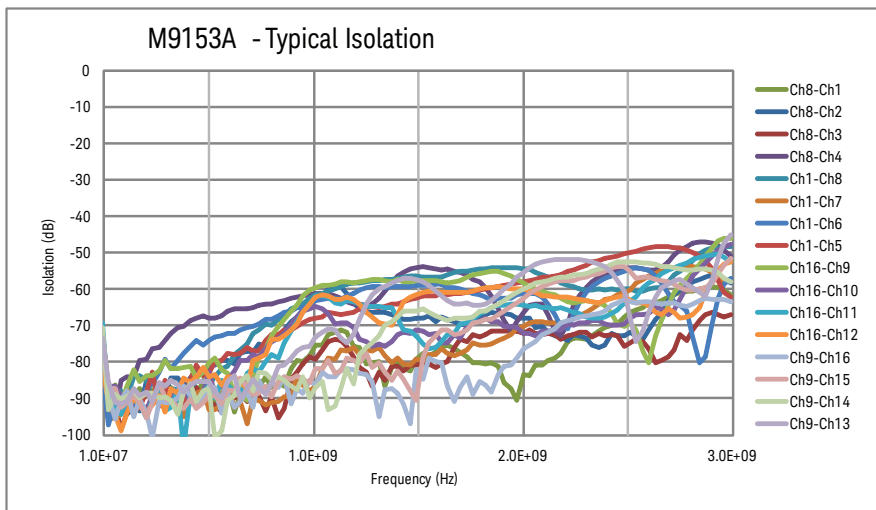
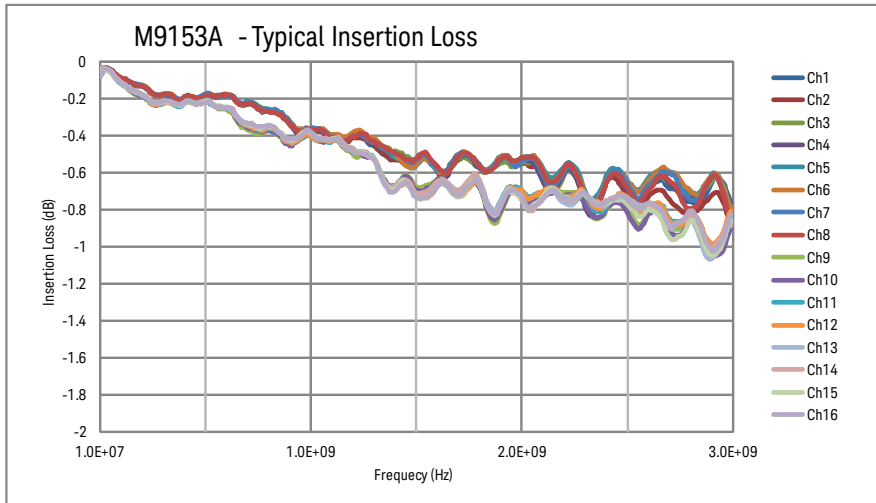

# Specifications and Characteristics

## M9153A typical characteristics (continued)

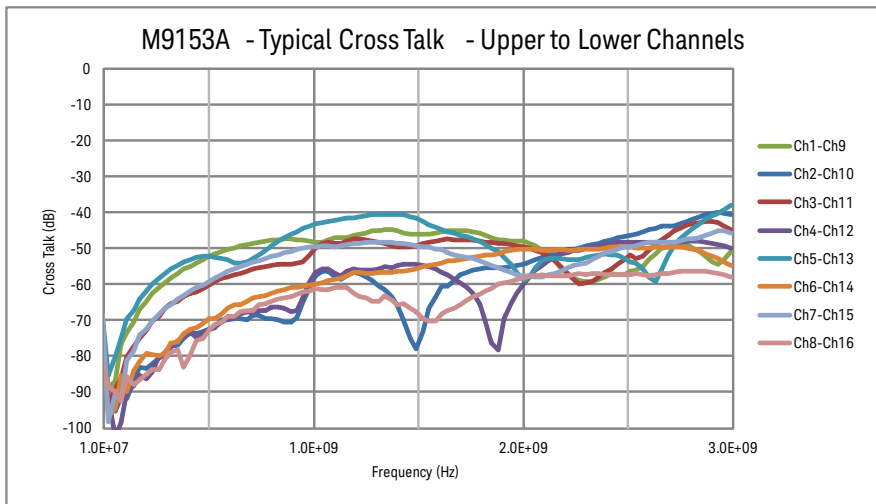
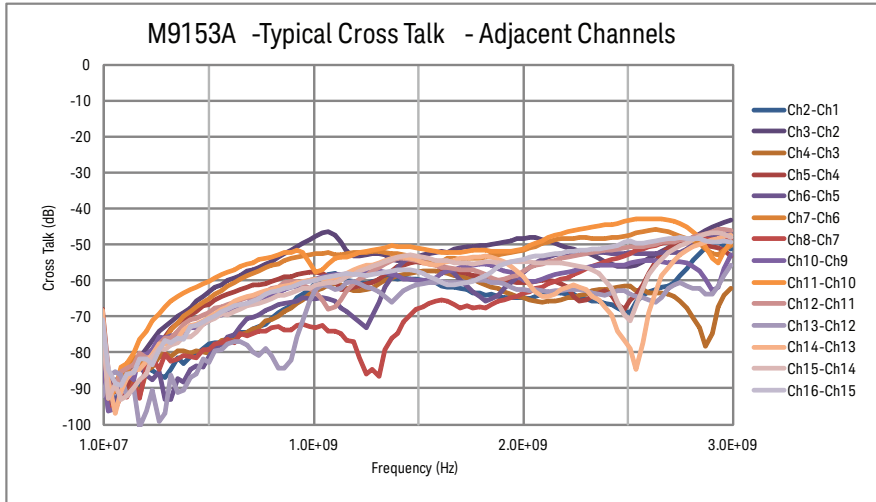

## Specifications and Characteristics

### General specifications

Connector type	SMB male
Slot type	PXI 1 slot

### Environmental characteristics <sup>1,2</sup>

Temperature	Operating: 0° to 55°C Non-operating: -40° to +70°C
Relative humidity	Relative humidity: Up to 95% R.H. at 40° C, non-condensing, pollution degree 1
EMC	European EMC Directive 2004/108/EC - IEC/EN 61326-1 - CISPR Pub 11 Group 1, Class A - AS/NZS CISPR 11 - ICES/NMB-001 Canadian ISM device ICS-001
Safety	European Low Voltage Directive 2006/95/EC - ETL, UL/IEC/EN 61010-1, 2nd Edition
Altitude under relative humidity	Altitude: up to 4.6 km (15,000 ft)
Warm-up time	45 minutes, max

1. Samples of this product have been type tested in accordance with the Keysight Environmental Test Manual and verified to be robust against the environmental stresses of storage, transportation, and end-use; those stresses include, but are not limited to temperature, humidity, shock, vibration, altitude, and power line conditions.

2. Test methods are aligned with IEC 60068-2 and levels are similar to MIL-PRF-28800F class 3.

### Physical characteristics

Dimensions	- 3U/1-slot PXI/CompactPCI standard - Connector slot compatibility: cPCI (J1), PXI-1, PXIe hybrid slot - Front panel complies with IEEE1101.10 certification and compliance
------------	---

#### Weight

	M9128A	M9146A	M9147A	M9148A	M9149A	M9150A	M9151A	M9152A	M9153A
	340 g (.75 lbs)	240 g (.53 lbs)	260 g (.57 lbs)	240 g (.53 lbs)	250 g (.55 lbs)	230 g (.51 lbs)	250 g (.55 lbs)	230 g (.51 lbs)	260 g (.57 lbs)

## Specifications and Characteristics

Power requirements									
	M9128A	M9146A	M9147A	M9148A	M9149A	M9150A	M9151A	M9152A	M9153A
+3.3V	0.03 A	0.03 A	0.03 A	0.03 A	0.03 A	0.03 A	0.03 A	0.03 A	0.03 A
+5V	0.8 A	0.21 A	0.4 A	0.21 A	0.18 A	0.27 A	0.27 A	0.21 A	0.18 A
+12V	0	0	0	0	0	0	0	0	0

System requirements			
Operating systems	Windows XP, Service Pack 3 or later (32-bit)	Windows Vista, SP1 and SP2 (32-bit and 64-bit), Business, Ultimate, Enterprise, Home Basic, and Home Premium	Windows 7 (32-bit and 64-bit) Starter, Home Basic, Home Premium, Professional, Ultimate, Enterprise
Processor speed	600MHz or higher required 800MHz recommended	1GHz 32-bit (x86), 1 GHz 64-bit (x64), no support for Itanium64	1GHz 32-bit (x86), 1GHz 64-bit (x64), no support for Itanium 64
Available memory	256 MB minimum (1 GB or greater recommended)	1 GB minimum	1 GB minimum
Available disk space <sup>1</sup>	1.5 GB available hard disk space, includes: – 1GB available for Microsoft .NET Framework 3.5 SP1 <sup>2</sup> – 100MB for Keysight IO Libraries Suite	1.5 GB available hard disk space, includes: – 1GB available for Microsoft .NET Framework 3.5 SP12 – 100MB for Keysight IO Libraries Suite	1.5 GB available hard disk space, includes: – 1GB available for Microsoft .NET Framework 3.5 SP12 – 100MB for Keysight IO Libraries Suite
Video	Super VGA (800x600) 256 colors or more	Support for DirectX 9 graphics with 128MB graphics memory recommended (Super VGA graphics is supported)	Support for DirectX 9 graphics with 128MB graphics memory recommended (Super VGA graphics is supported)
Browser	Microsoft Internet Explorer 6.0 or greater	Microsoft Internet Explorer 7 or greater	Microsoft Internet Explorer 7 or greater

1. Because of the installation procedure, less memory may required for operation than is required for installation.

2. NET Framework Runtime Components are installed by default with Windows Vista and Windows 7. Therefore, you may not need this amount of available disk space.



# CONFIGURATION AND ORDERING

## Hardware

Model	Description
Each RF switch includes:	Getting started guide, software drivers, and Keysight I/O libraries
M9128A	PXI RF matrix switch: 300 MHz, 8x12, 50 $\Omega$
M9146A	PXI RF multiplexer: 3 GHz, dual 1x4, 50 $\Omega$ , terminated
M9147A	PXI RF multiplexer: 3 GHz, quad 1x4, 50 $\Omega$ , terminated common
M9148A	PXI RF multiplexer: 3 GHz, 1x8, 50 $\Omega$
M9149A	PXI high-density RF multiplexer: 3 GHz, 1x16, 50 $\Omega$
M9150A	PXI RF multiplexer: 3 GHz, dual 1x4, 75 $\Omega$
M9151A	PXI RF multiplexer: 3 GHz, quad 1x4, 75 $\Omega$
M9152A	PXI RF multiplexer: 3 GHz, 1x8, 75 $\Omega$
M9153A	PXI high-density RF multiplexer: 3 GHz, 1x16, 75 $\Omega$

## Recommended RF switch chassis configuration

For the ultimate in speed and flexibility, combine your RF switches with other PXI modules in the Keysight M9018A PXIe chassis as follows:

- Select a PXIe system module or embedded controller (the Keysight M9021A is recommended)
- If an external computer is being used, select an appropriate PC interface card (the Keysight M9048A is recommended with an external PC)
- Select an appropriate cable to connect the computer interface board to the system module (the Y1202A is recommended to connect the M9048A and M9021A)
- Select rack mount and EMC filler panel kits as required

## Related products

Model	Description
M9018A	18-slot PXIe chassis
M9021A	PCIe® cable interface
M9045B	PCIe ExpressCard adaptor: Gen 1
Y1200B	PCIe cable: x4 to x8, 2.0m (used with M9045A)
M9048A	PCIe desktop PC adapter: Gen 2, x8
Y1202A	PCIe cable: x8, 2.0m (used with M9048A)

## Software

Model	Description
Supported operating systems	Microsoft Windows XP (32-bit), Microsoft Windows Vista (32/64-bit), Microsoft Windows 7 (32/64-bit)
Standard compliant drivers	IVI-COM, IVI-C, LabVIEW, MATLAB
Supported application development environments (ADE)	VisualStudio (VB.NET, C#, C/C++), LabVIEW, LabWindows/CVI, MATLAB
Keysight IO libraries	Includes: VISA Libraries, Keysight Connection Expert, IO Monitor

## Definitions for specifications

Specifications describe the warranted performance of calibrated instruments that have been stored for a minimum of 2 hours within the operating temperature range of 0 to 55°C, unless otherwise stated, and after a 45 minute warm-up period. Data represented in this document are specifications unless otherwise noted.

Characteristics describe product performance that is useful in the application of the product. Characteristics are often referred to as Typical or Nominal values.

- Typical describes characteristic performance, which 80% of the instruments will meet when operated over a 20 to 30°C temperature range. Typical performance is not warranted.
- Nominal describes representative performance that is useful in the application of the product when operated over a 20 to 30°C temperature range. Nominal performance is not warranted.

*Note: All graphs contain measured data from several units at room temperature unless otherwise noted.*

## Calibration

### Advantage Services: Calibration

Keysight Advantage Services is committed to your success throughout your equipment's lifetime.

